



TEST REPORT

Applicant Name & Address : Eaglerise Electronics (Foshan) Co., Ltd.
No. 4, East Huanzhen Road, Beijiao, Shunde, Foshan, Guangdong, 528000, China
Manufacturing Site : Same as applicant

Sample Description

Product : Electronic controlgear for LED (Electronic LED driver)
Model No. : EIP012C****LS

Remark:

The 1st to 4th "*" indicate the output current of LED driver; can be replaced by "0250" to "1200" and increasing in multiplies of 50. "0250" means 250 mA; "1200" means 1200 mA.

Electrical Rating : Input: 220-240 VAC; 50/60 Hz; 0,09 A; Class II; IP 20; SELV; ta 50 °C; tc 75 °C; Independent type; 110 °C thermal protection; Inherently short-circuit proof; Output: Constant current type for output; MM mark; Suitable for direct mounting on normally flammable surfaces; Other parameters refer to Page 5 Model list

Date Received : 05 June 2012
Date Test Conducted : 08 June 2012 – 15 June 2012
Test standards : EN 62493: 2010
Test Result : Pass
Conclusion : The submitted samples complied with the above light EMF standard.

Remark : When determine the test result, measurement uncertainty has been considered.

*****End of Page*****

Prepared and Checked By:

Approved By:

Helen Ma
Helen Ma
Project Engineer
Intertek Guangzhou

Steven Zhou *Signature*
Steven Zhou
Sr.Project Engineer
Intertek Guangzhou
02 Aug., 2012 *Date*

This report is for the exclusive use of Intertek's Client and is provided pursuant to the agreement between Intertek and its Client. Intertek's responsibility and liability are limited to the terms and conditions of the agreement. Intertek assumes no liability to any party, other than to the Client in accordance with the agreement, for any loss, expense or damage occasioned by the use of this report. Only the Client is authorized to permit copying or distribution of this report and then only in its entirety. Any use of the Intertek name or one of its marks for the sale or advertisement of the tested material, product or service must first be approved in writing by Intertek. The observations and test results in this report are relevant only to the sample tested. This report by itself does not imply that the material, product, or service is or has ever been under an Intertek certification program. The test report only allows to be revised within three years from its original issued date unless further standard or the requirement was noticed.

Intertek Testing Services Shenzhen Ltd. Guangzhou Branch
Block E, No.7-2 Guang Dong Software Science Park, Caipin Road, Guangzhou Science City, GETDD Guangzhou, China
Tel / Fax: 86-20-8213 9688/86-20-3205 7538

CONTENT

TEST REPORT.....	1
CONTENT.....	2
1 TEST RESULTS SUMMARY	3
2 EMF RESULTS CONCLUSION.....	4
3 LABORATORY MEASUREMENTS	6
4 EMI TEST.....	7
4.1 DISTURBANCE VOLTAGE ON MAINS TERMINALS (20 kHz-30 MHz).....	7
4.1.1 Used Test Equipment	7
4.1.2 Block Diagram of Test Setup.....	7
4.1.3 Test Setup and Procedure	7
4.1.4 Test Data.....	8
4.1.5 Emission Curve	11
4.1.6 Measurement Uncertainty.....	14
4.2 RADIATED ELECTROMAGNETIC DISTURBANCE (100 kHz -30 MHz).....	15
4.2.1 Used Test Equipment	15
4.2.2 Block Diagram of Test Setup.....	15
4.2.3 Test Setup and Procedure	15
4.2.4 Test Data.....	16
4.2.5 Test Curve.....	17
4.2.6 Measurement Uncertainty.....	21
4.3 RADIATED ELECTROMAGNETIC DISTURBANCE (30-300MHz, CDN METHOD).....	22
4.3.1 Used Test Equipment	22
4.3.2 Block Diagram of Test Setup.....	22
4.3.3 Test Setup and Procedure	22
4.3.4 Test Data.....	23
4.3.5 Test Curve.....	24
4.3.6 Measurement uncertainty.....	26
4.4 INDUCED CURRENT DENSITY (20 kHz-10 MHz).....	26
4.4.1 Used Test Equipment	26
4.4.2 Block Diagram of Test Setup.....	26
4.4.3 Test Setup and Procedure	26
4.4.4 Test Data.....	27
4.4.5 Test Curve.....	27
4.4.6 Measurement uncertainty.....	28
5 APPENDIX I - PHOTOS OF TEST SETUP	29
6 APPENDIX II- PHOTOS OF EUT.....	31

1

TEST RESULTS SUMMARY

Test Item	Standard	Result
Disturbance Voltage on Mains Terminals (20kHz-30MHz)	EN 62493: 2010 Reference: EN 55015: 2006+A1:2007+A2:2009	Pass
Radiated Electromagnetic Disturbance (100kHz-30MHz)	EN 62493: 2010 Reference: EN 55015: 2006+A1:2007+A2:2009	Pass
Radiated Electromagnetic Disturbance (30-300MHz)	EN 62493: 2010 Reference: EN 55015: 2006+A1:2007+A2:2009	Pass
Induced Current Density (20kHz-10MHz)	EN 62493: 2010	Pass

Remark: 1. The symbol "N/A" in above table means Not Applicable.

2. When determining the test results, measurement uncertainty of tests has been considered.

2**EMF Results Conclusion**
(with Justification)

We tested the Electronic controlgear for LED (Electronic LED driver), Model: EIP012C1200LS, EIP012C0700LS, EIP012C0250LS, to determine if it was in compliance with the relevant EN standards as marked on the Test Results Summary. We found that the unit met the requirement of EN 62493 standard when tested as received. The worst case's test data was presented in this test report.

All models had the same mechanical structure, output load, PCB layout; the only difference is the parameters for the components used in secondary circuit. Model EIP012C1200LS, EIP012C0700LS, EIP012C0250LS were selected to do the full tests based on above statement.

The production units are required to conform to the initial sample as received when the units are placed on the market.

Model list:

Model	Rated input voltage	Frequency	Output voltage range	Max. output voltage
EIP012C0250LS	220-240VAC	50/60Hz	24V-48VDC	52VDC
EIP012C0300LS	220-240VAC	50/60Hz	20V-40VDC	45VDC
EIP012C0350LS	220-240VAC	50/60Hz	17V-34VDC	40VDC
EIP012C0400LS	220-240VAC	50/60Hz	15V-30VDC	35VDC
EIP012C0450LS	220-240VAC	50/60Hz	13.3V-26.7VDC	32VDC
EIP012C0500LS	220-240VAC	50/60Hz	12V-24VDC	28VDC
EIP012C0550LS	220-240VAC	50/60Hz	11V-22VDC	26VDC
EIP012C0600LS	220-240VAC	50/60Hz	10V-20VDC	24VDC
EIP012C0650LS	220-240VAC	50/60Hz	9V-18.5VDC	23VDC
EIP012C0700LS	220-240VAC	50/60Hz	9V-17VDC	21VDC
EIP012C0750LS	220-240VAC	50/60Hz	8V-16VDC	20VDC
EIP012C0800LS	220-240VAC	50/60Hz	7.5V-15VDC	19VDC
EIP012C0850LS	220-240VAC	50/60Hz	7V-14.1VDC	18VDC
EIP012C0900LS	220-240VAC	50/60Hz	6.6V-13.3VDC	17VDC
EIP012C0950LS	220-240VAC	50/60Hz	6.3V-12.6VDC	16VDC
EIP012C1000LS	220-240VAC	50/60Hz	6V-12VDC	16VDC
EIP012C1050LS	220-240VAC	50/60Hz	5.7V-11.4VDC	15VDC
EIP012C1100LS	220-240VAC	50/60Hz	5.5V-11VDC	15VDC
EIP012C1150LS	220-240VAC	50/60Hz	5.2V-10.4VDC	14VDC
EIP012C1200LS	220-240VAC	50/60Hz	5V-10VDC	13VDC

3

LABORATORY MEASUREMENTS**Configuration Information**

Equipment Under Test (EUT):	Electronic controlgear for LED (Electronic LED driver)
Model:	EIP012C1200LS, EIP012C0700LS, EIP012C0250LS
Serial No.	Not Labeled
Support Equipment:	LED diode as load, supplied by client
Rated Voltage:	220-240V/50/60Hz
Condition of Environment:	Temperature : 15~25°C Relative Humidity: 35~60% Atmosphere Pressure 86~106kPa

Notes:

The EMI measurements had been made in the operating mode produced the largest emission in the frequency band being investigated consistent with normal applications.

An attempt had been made to maximize the emission by varying the configuration of the EUT.

4 EMI TEST

4.1 Disturbance Voltage on Mains Terminals (20 kHz-30 MHz)

Test Result: Pass

4.1.1 Used Test Equipment

Equipment No.	Equipment	Model	Manufacturer
EM080-05	EMI receiver	ESCI	R&S
EM006-05	LISN	ENV216	R&S
EM004-04	EMC shield Room	8m×3m×3m	Zhongyu

4.1.2 Block Diagram of Test Setup

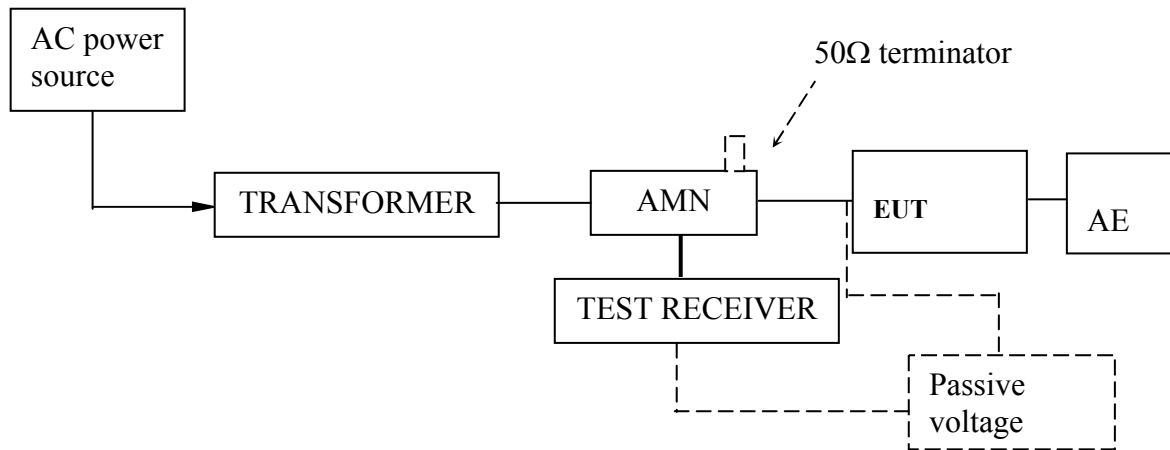

4.1.3 Test Setup and Procedure

The EUT was set to achieve the maximum emission level. The mains terminal disturbance voltage was measured with the EUT in a shielded room. The EUT was connected to AC power source through an Artificial Mains Network which provide a 50Ω linear impedance Artificial hand is used if appropriate (for handheld apparatus). The load/control terminal disturbance voltage was measured with passive voltage probe if appropriate.

The EUT was placed on a 0.4m high non-metallic table above a metallic plane, and 0.4m from wall of shielded room which is considered as Ground Reference Plane (GRP) (For floor standing EUT, was placed on a 0.1m high non-metallic supported on GRP) The EUT keeps a distance of at least 0.8m from any other of the metallic surface. The Artificial Mains Network is situated at a distance of 0.8m from the EUT.

During the test, mains lead of EUT excess 0.8m was folded back and forth parallel to the lead so as to form a horizontal bundle with a length between 0.3m and 0.4m.

The bandwidth of test receiver was set at 200Hz in the frequency range from 20kHz to 150kHz, and 9kHz in the frequency range from 150kHz to 30MHz.

4.1.4 Test Data

At main terminal: Pass

Model: EIP012C0250LS

Tested Wire: Live

Operation Mode: on mode

EDIT PEAK LIST (Final Measurement Results)				
Trace1:	CE1511QP			
Trace2:	CE1511AV			
Trace3:	---			
TRACE	FREQUENCY	LEVEL dBµV		DELTA LIMIT dB
2 Average	426 kHz	42.67	L1	-4.65
1 Quasi Peak	566 kHz	49.05	L1	-6.94
1 Quasi Peak	426 kHz	50.37	L1	-6.95
2 Average	574 kHz	39.03	L1	-6.96
1 Quasi Peak	286 kHz	52.56	L1	-8.07
2 Average	1.194 MHz	36.73	L1	-9.26
2 Average	1.59 MHz	36.53	L1	-9.46
2 Average	286 kHz	41.16	L1	-9.48
2 Average	3.042 MHz	36.30	L1	-9.70
2 Average	16.086 MHz	39.26	L1	-10.73
1 Quasi Peak	1.126 MHz	44.69	L1	-11.30
2 Average	150 kHz	43.14	L1	-12.85
1 Quasi Peak	3.086 MHz	42.71	L1	-13.28
1 Quasi Peak	1.498 MHz	42.62	L1	-13.37
1 Quasi Peak	15.802 MHz	43.63	L1	-16.36
1 Quasi Peak	174 kHz	48.03	L1	-16.73
1 Quasi Peak	4.878 MHz	35.58	L1	-20.41

Tested Wire: Neutral

Operation Mode: on mode

EDIT PEAK LIST (Final Measurement Results)				
Trace1:	CE1511QP			
Trace2:	CE1511AV			
Trace3:	---			
TRACE	FREQUENCY	LEVEL dBµV		DELTA LIMIT dB
2 Average	478 kHz	40.98	L1	-5.38
2 Average	566 kHz	40.51	L1	-5.48
1 Quasi Peak	282 kHz	54.69	L1	-6.05
1 Quasi Peak	570 kHz	49.46	L1	-6.53
2 Average	282 kHz	44.14	L1	-6.61
1 Quasi Peak	466 kHz	49.16	L1	-7.41
2 Average	1.126 MHz	37.48	L1	-8.51
2 Average	1.594 MHz	37.10	L1	-8.89
2 Average	3.162 MHz	36.45	L1	-9.54
1 Quasi Peak	1.194 MHz	45.68	L1	-10.31
2 Average	158 kHz	43.26	L1	-12.30
1 Quasi Peak	3.098 MHz	42.90	L1	-13.09
1 Quasi Peak	158 kHz	52.24	L1	-13.31
1 Quasi Peak	1.474 MHz	42.56	L1	-13.43
1 Quasi Peak	15.81 MHz	46.14	L1	-13.85
2 Average	16.094 MHz	35.67	L1	-14.32
1 Quasi Peak	4.214 MHz	34.90	L1	-21.09
1 Quasi Peak	9.75 MHz	38.79	L1	-21.20



Model: EIP012C0700LS

Tested Wire: Live

Operation Mode: on mode

EDIT PEAK LIST (Final Measurement Results)				
Trace1:	CE1511QP			
Trace2:	CE1511AV			
Trace3:	---			
TRACE	FREQUENCY	LEVEL dBμV		DELTA LIMIT dB
2 Average	454 kHz	38.93	L1	-7.86
2 Average	538 kHz	38.08	L1	-7.91
2 Average	1.358 MHz	37.49	L1	-8.50
2 Average	3.162 MHz	37.48	L1	-8.51
1 Quasi Peak	438 kHz	47.84	L1	-9.25
1 Quasi Peak	658 kHz	46.12	L1	-9.87
2 Average	1.838 MHz	36.11	L1	-9.89
1 Quasi Peak	906 kHz	45.36	L1	-10.63
1 Quasi Peak	278 kHz	49.28	L1	-11.58
2 Average	230 kHz	40.38	L1	-12.06
1 Quasi Peak	3.23 MHz	43.73	L1	-12.26
2 Average	154 kHz	42.67	L1	-13.10
1 Quasi Peak	158 kHz	52.34	L1	-13.22
1 Quasi Peak	1.746 MHz	42.68	L1	-13.31
2 Average	16.074 MHz	35.35	L1	-14.64
1 Quasi Peak	4.966 MHz	36.03	L1	-19.97

Tested Wire: Neutral

Operation Mode: on mode

EDIT PEAK LIST (Final Measurement Results)				
Trace1:	CE1511QP			
Trace2:	CE1511AV			
Trace3:	---			
TRACE	FREQUENCY	LEVEL dBμV		DELTA LIMIT dB
2 Average	442 kHz	41.39	L1	-5.63
2 Average	558 kHz	39.29	L1	-6.70
2 Average	3.266 MHz	38.47	L1	-7.52
1 Quasi Peak	450 kHz	49.29	L1	-7.58
2 Average	1.286 MHz	38.10	L1	-7.89
2 Average	282 kHz	42.60	L1	-8.14
2 Average	1.85 MHz	36.85	L1	-9.14
1 Quasi Peak	542 kHz	46.47	L1	-9.52
1 Quasi Peak	1.286 MHz	46.07	L1	-9.92
1 Quasi Peak	298 kHz	49.76	L1	-10.53
1 Quasi Peak	3.206 MHz	45.13	L1	-10.86
2 Average	166 kHz	43.58	L1	-11.57
1 Quasi Peak	1.466 MHz	43.74	L1	-12.25
1 Quasi Peak	174 kHz	51.36	L1	-13.40
2 Average	3.966 MHz	31.05	L1	-14.94
2 Average	16.09 MHz	32.20	L1	-17.79
1 Quasi Peak	4.138 MHz	37.43	L1	-18.56



Model: EIP012C1200LS

Tested Wire: Live

Operation Mode: on mode

EDIT PEAK LIST (Final Measurement Results)				
Trace1:	CE1511QP			
Trace2:	CE1511AV			
Trace3:	---			
TRACE	FREQUENCY	LEVEL dBµV		DELTA LIMIT dB
2 Average	474 kHz	41.36 L1		-5.07
2 Average	778 kHz	39.85 L1		-6.14
2 Average	310 kHz	43.18 L1		-6.78
1 Quasi Peak	310 kHz	52.72 L1		-7.24
2 Average	2.846 MHz	38.38 L1		-7.61
2 Average	1.354 MHz	37.79 L1		-8.20
2 Average	1.458 MHz	37.59 L1		-8.40
1 Quasi Peak	450 kHz	48.45 L1		-8.41
1 Quasi Peak	778 kHz	47.55 L1		-8.45
1 Quasi Peak	942 kHz	45.04 L1		-10.95
1 Quasi Peak	2.826 MHz	44.94 L1		-11.05
2 Average	166 kHz	42.82 L1		-12.33
1 Quasi Peak	1.706 MHz	42.93 L1		-13.07
1 Quasi Peak	170 kHz	51.35 L1		-13.60
1 Quasi Peak	4.77 MHz	36.81 L1		-19.19
1 Quasi Peak	9.658 MHz	31.88 L1		-28.11

Tested Wire: Neutral

Operation Mode: on mode

EDIT PEAK LIST (Final Measurement Results)				
Trace1:	CE1511QP			
Trace2:	CE1511AV			
Trace3:	---			
TRACE	FREQUENCY	LEVEL dBµV		DELTA LIMIT dB
2 Average	306 kHz	46.15 L1		-3.92
2 Average	474 kHz	42.02 L1		-4.41
1 Quasi Peak	306 kHz	54.89 L1		-5.18
2 Average	766 kHz	40.20 L1		-5.79
1 Quasi Peak	458 kHz	50.10 L1		-6.62
2 Average	2.814 MHz	38.90 L1		-7.09
2 Average	1.326 MHz	38.28 L1		-7.71
2 Average	1.454 MHz	38.11 L1		-7.88
1 Quasi Peak	782 kHz	47.72 L1		-8.27
1 Quasi Peak	910 kHz	45.89 L1		-10.10
1 Quasi Peak	1.442 MHz	45.53 L1		-10.46
1 Quasi Peak	2.842 MHz	45.51 L1		-10.48
2 Average	166 kHz	44.24 L1		-10.91
1 Quasi Peak	178 kHz	51.45 L1		-13.11
2 Average	4.806 MHz	31.31 L1		-14.68
1 Quasi Peak	4.89 MHz	37.67 L1		-18.33

4.1.5 Emission Curve

At mains terminal:
 Model: EIP012C0250LS
 Tested Wire: Live

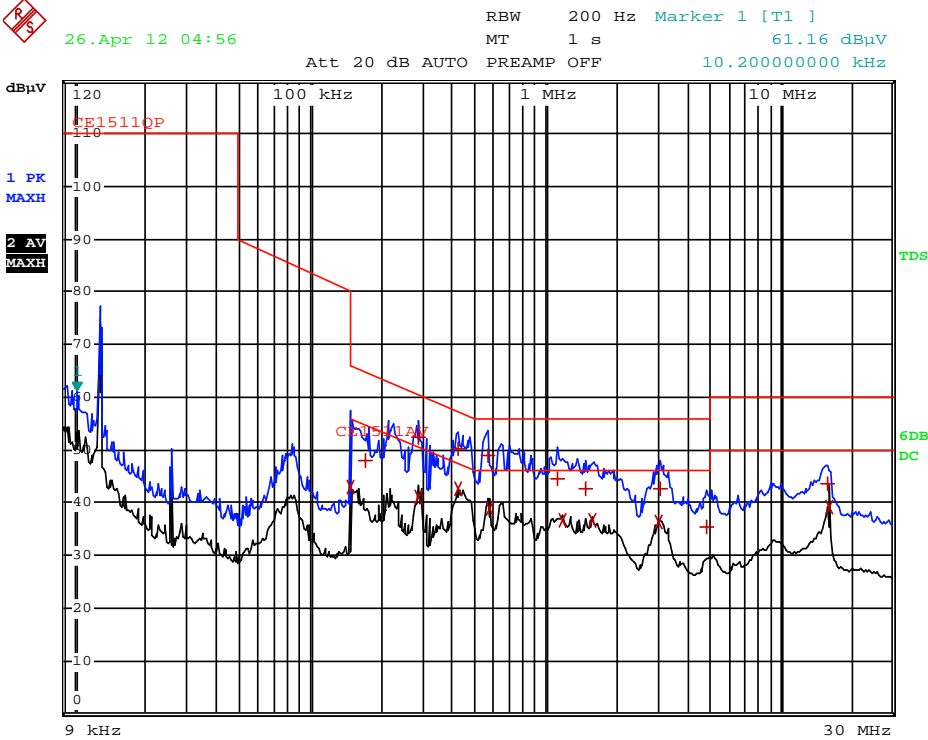

Tested Wire: Neutral

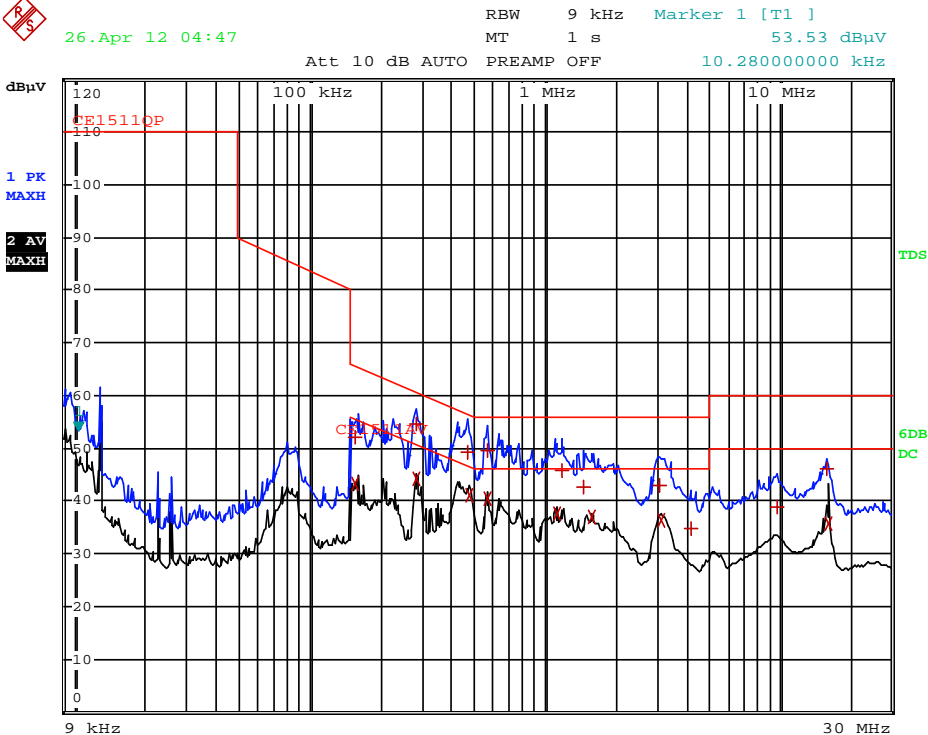



Model: EIP012C0700LS
Tested Wire: Live

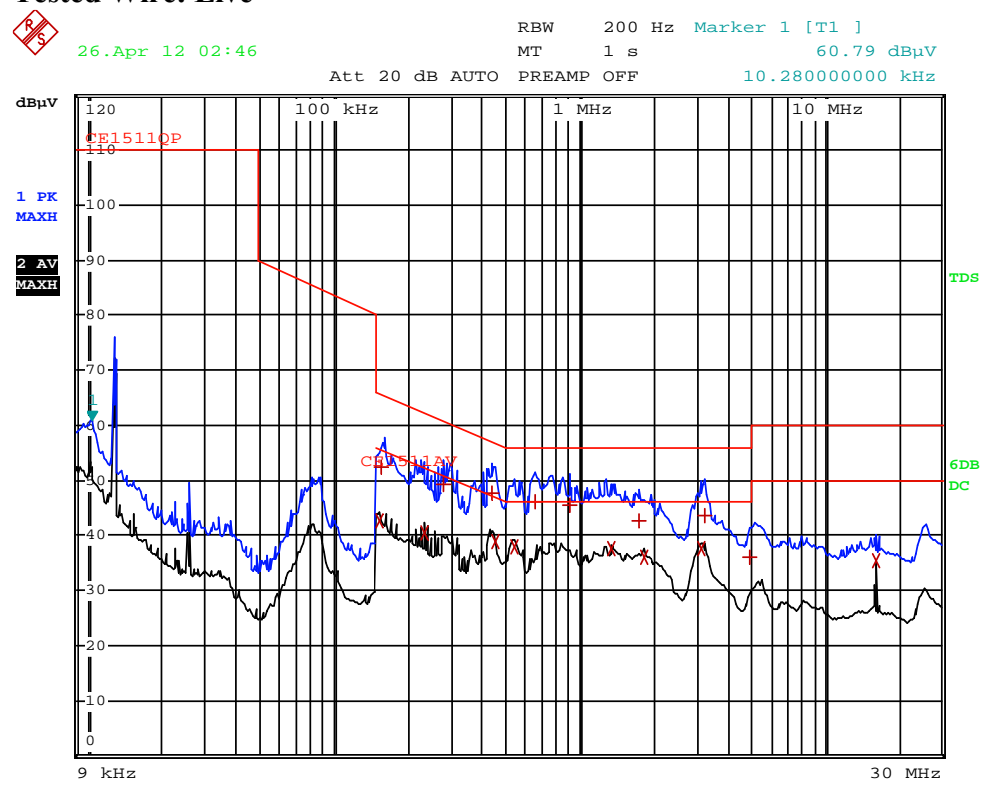

Tested Wire: Neutral

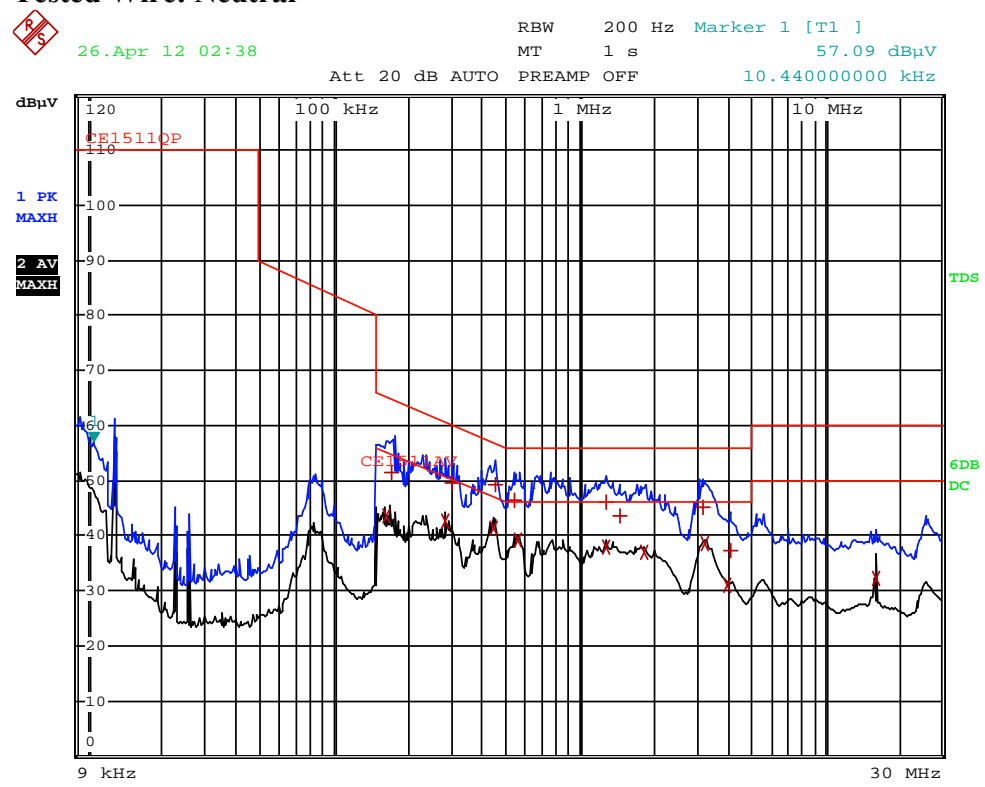



Model: EIP012C1200LS Tested Wire: Live

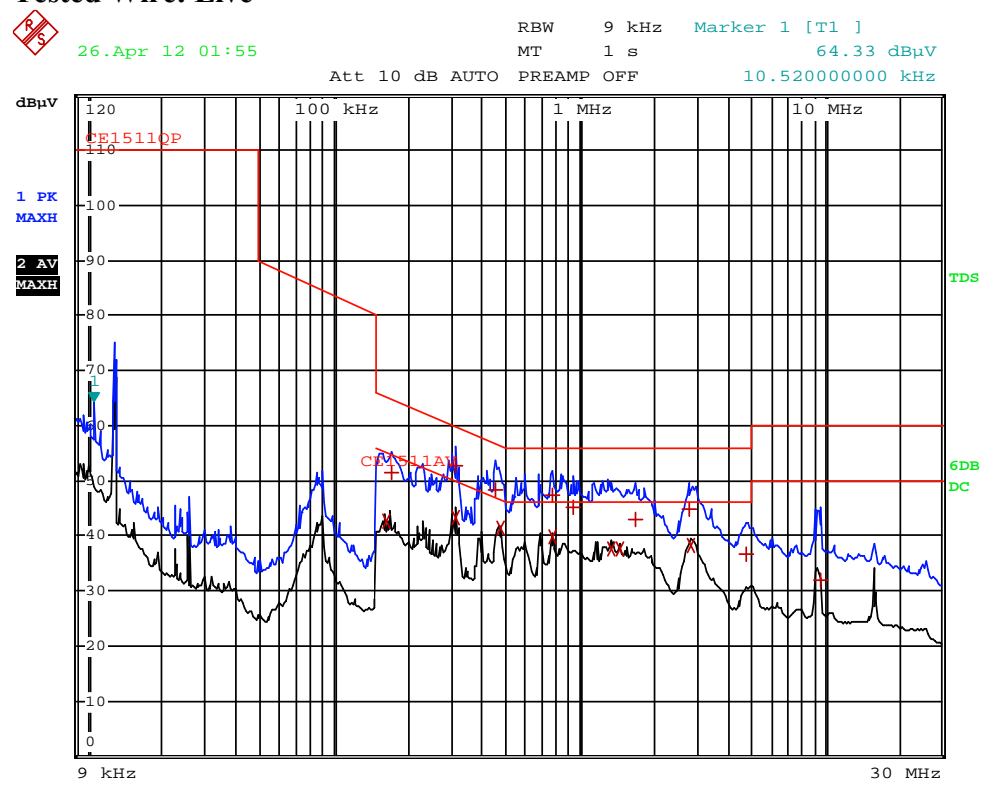

Tested Wire: Neutral

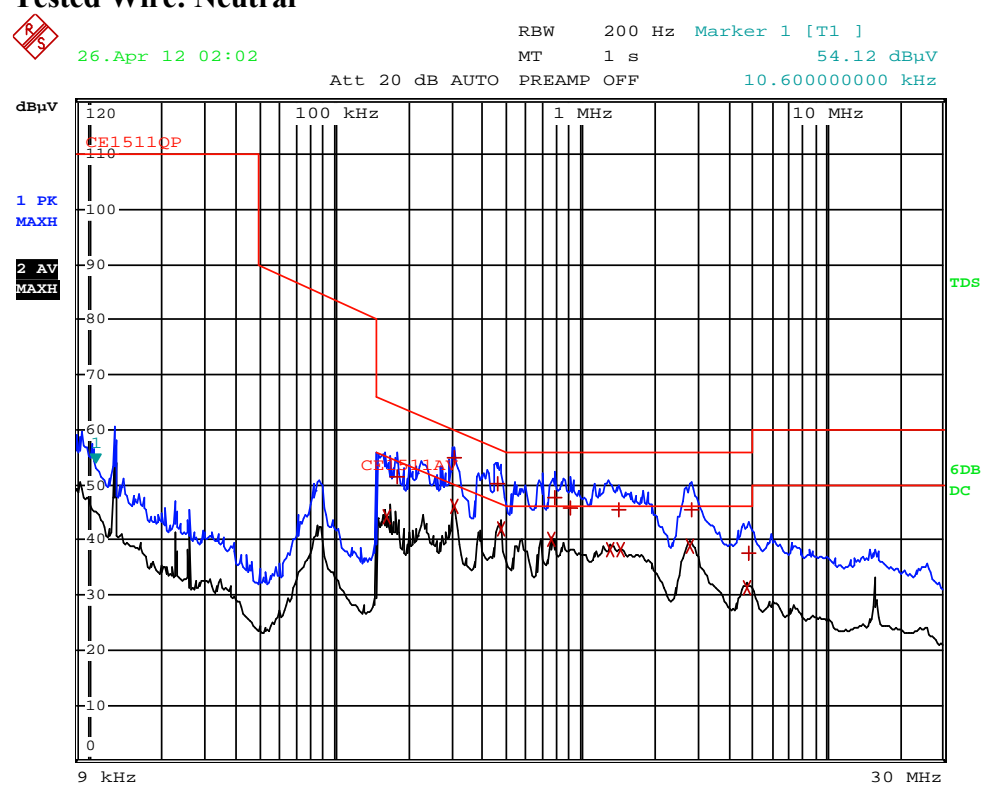

4.1.6 Measurement Uncertainty

The measurement uncertainty describes the overall uncertainty of the given measured value during the operation of the EUT.

Measurement uncertainty is calculated in accordance with CISPR 16-4-2: 2003.

Measurement uncertainty of mains terminal disturbance voltage in CISPR band A: 1.6 dB.

Measurement uncertainty of mains terminal disturbance voltage in CISPR band B: 2.3 dB.

The measurement uncertainty is given with a confidence of 95%, $k=2$.

4.2 Radiated Electromagnetic Disturbance (100 kHz -30 MHz)

Test Result: Pass

4.2.1 Used Test Equipment

Equipment No.	Equipment	Model	Manufacturer
EM080-04	EMI receiver	ESCS30	R&S
EM061-04	Triple Loop Antenna	HXYZ9170	SCHWARZBECK
EM004-03	EMC shield Room	8m×4m×3m	Zhongyu

4.2.2 Block Diagram of Test Setup

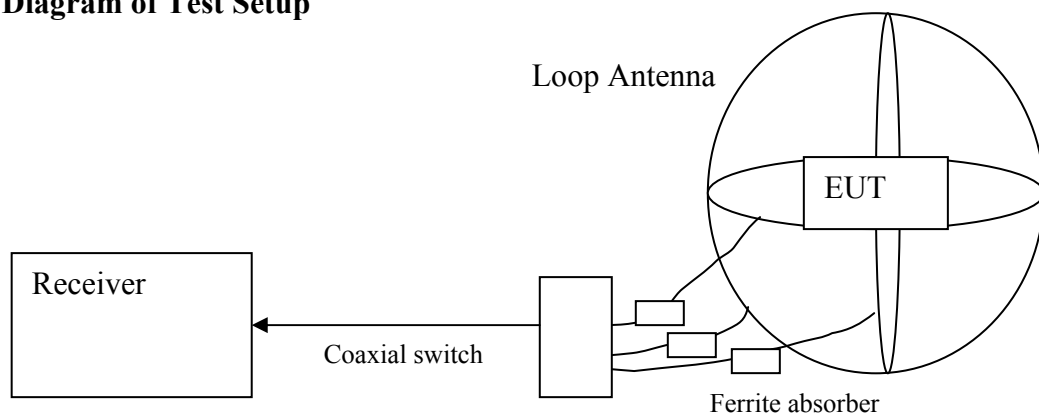

4.2.3 Test Setup and Procedure

The EUT is placed in the centre of the loop antenna system(LAS). The current induced by the magnetic field from the EUT into each of the three large loop antennas of the LAS is measured by connecting the current probe of the large loop antenna to a measuring receiver. During the measurements the EUT remains in a fixed position.

The currents in the three large loop antenna, origination from the three mutually orthogonal magnetic field components, are measured in sequence. Each current level measured shall comply with the emission limit, expressed in dB μ A, as specified in table of EN 55015.

The distance between the outer perimeter of the LAS and nearby objects, such as floor and walls, shall be at least 0.5m.

To avoid unwanted capacitive coupling between the EUT and the LAS, the maximum dimensions of the EUT shall allow a distance of at least 0.2m between the EUT and the standardized 2m large loop antenna of the LAS.

The position of the mains lead shall be optimized for maximum current induction. In general, this position will not be critical when the EUT complies with the conducted emission limit.

4.2.4 Test Data

For models: EIP012C0250LS, EIP012C0700LS, EIP012C1200LS

Frequency [MHz]	X axis [dB(μA)]	Y axis [dB(μA)]	Z axis [dB(μA)]	Limit [dB(μA)]
0.100	<64	<64	<64	74.0
0.160	<47	<47	<47	57.2
0.240	<40	<40	<40	52.4
0.550	<30	<30	<30	42.5
1.000	<25	<25	<25	35.4
1.400	<20	<20	<20	31.4
2.000	<17	<17	<17	27.1
3.500	<12	<12	<12	22.0
6.000	<12	<12	<12	22.0
10.000	<12	<12	<12	22.0
22.000	<12	<12	<12	22.0
30.000	<12	<12	<12	22.0

4.2.5 Test Curve

Model: EIP012C0250LS

X axis

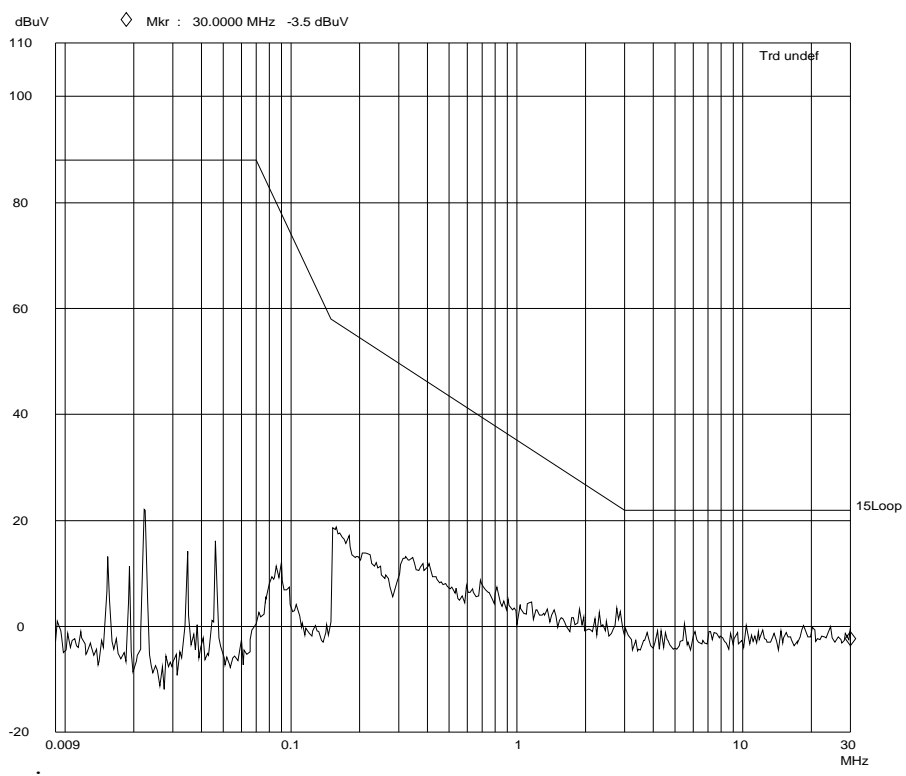

Y axis

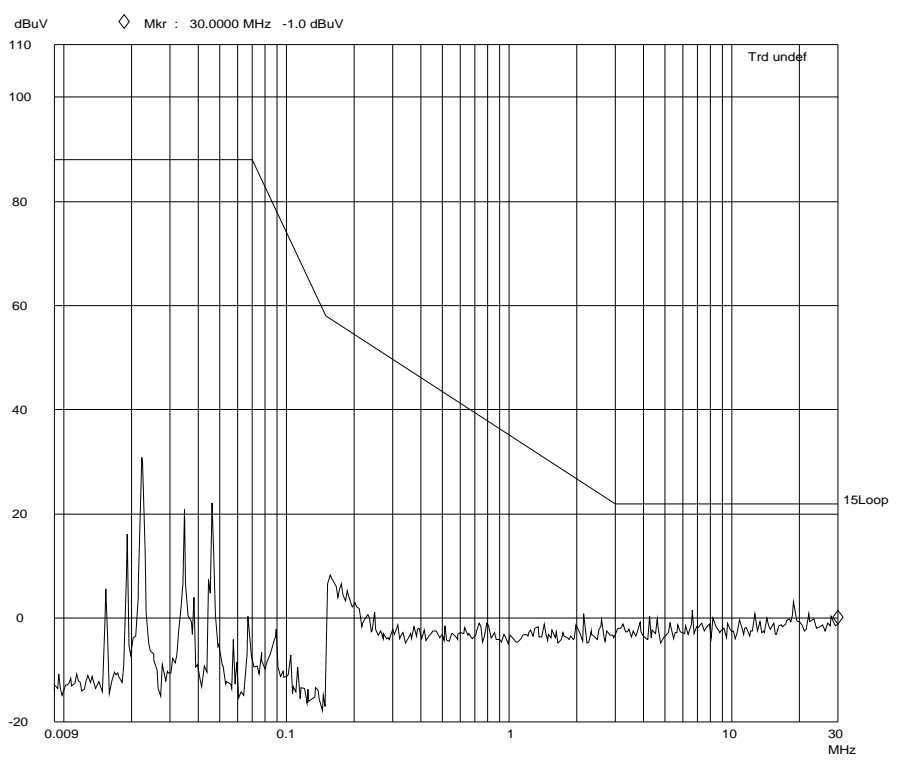

Z axis

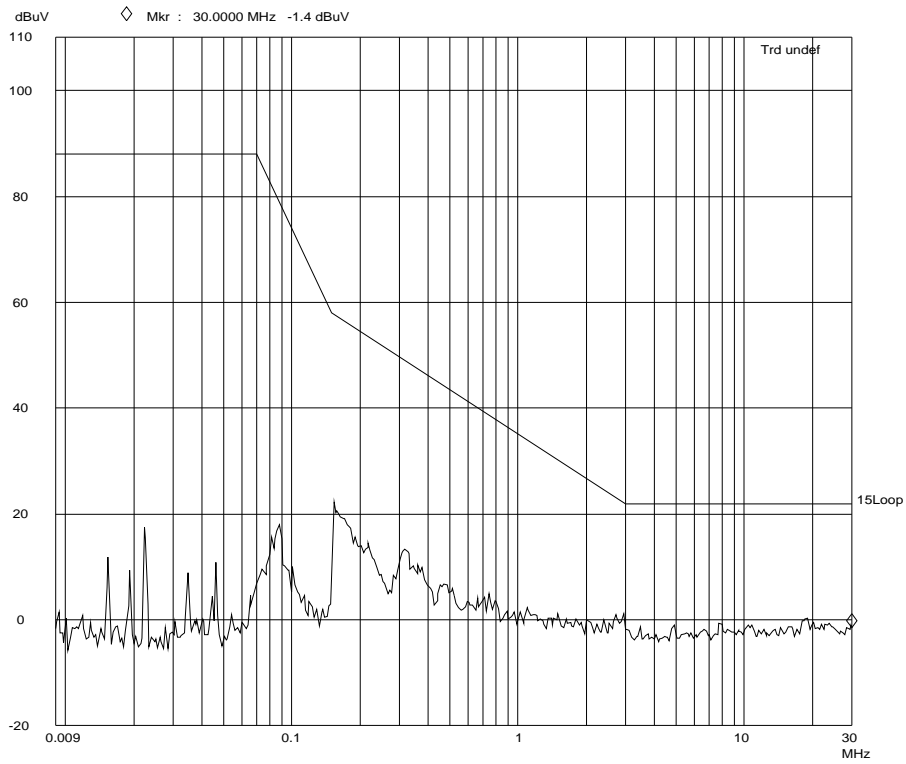

Model: EIP012C0700LS

X axis

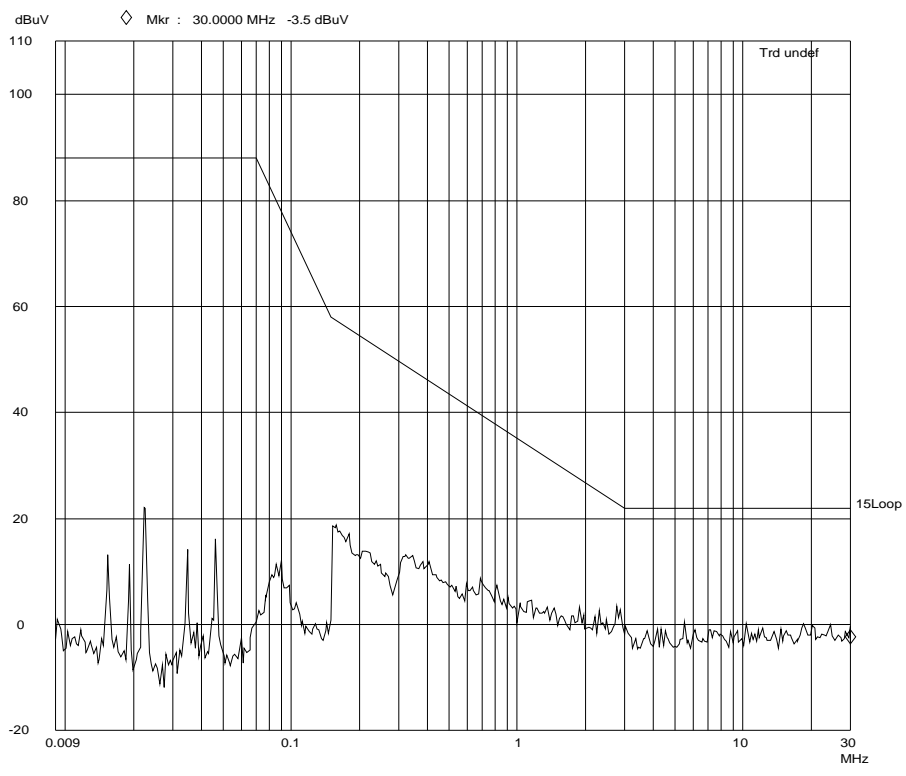

Y axis

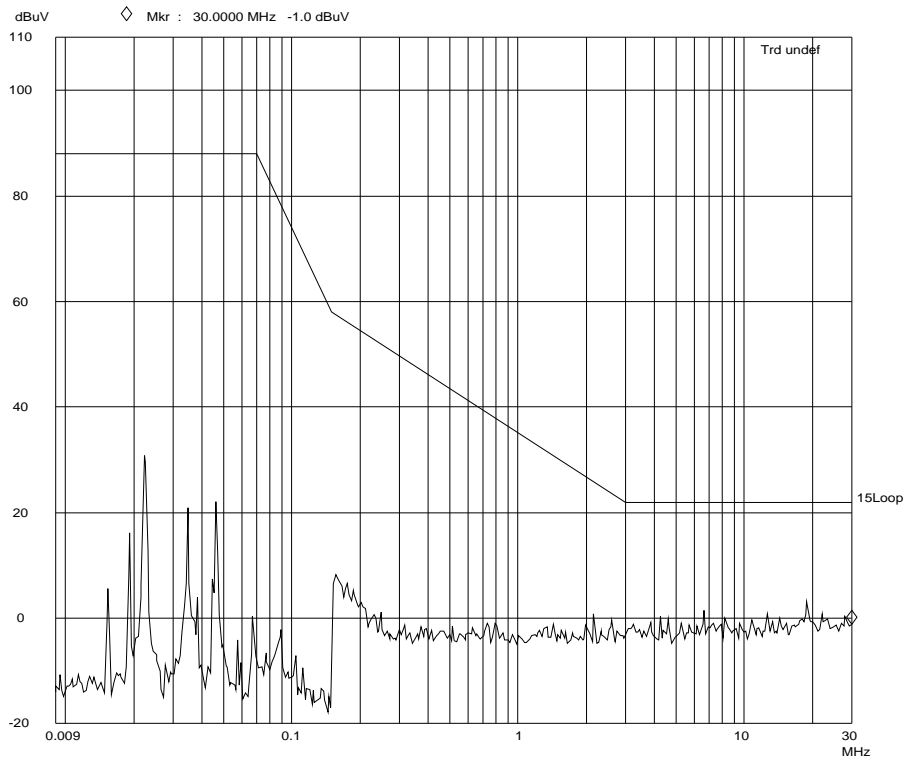

Z axis

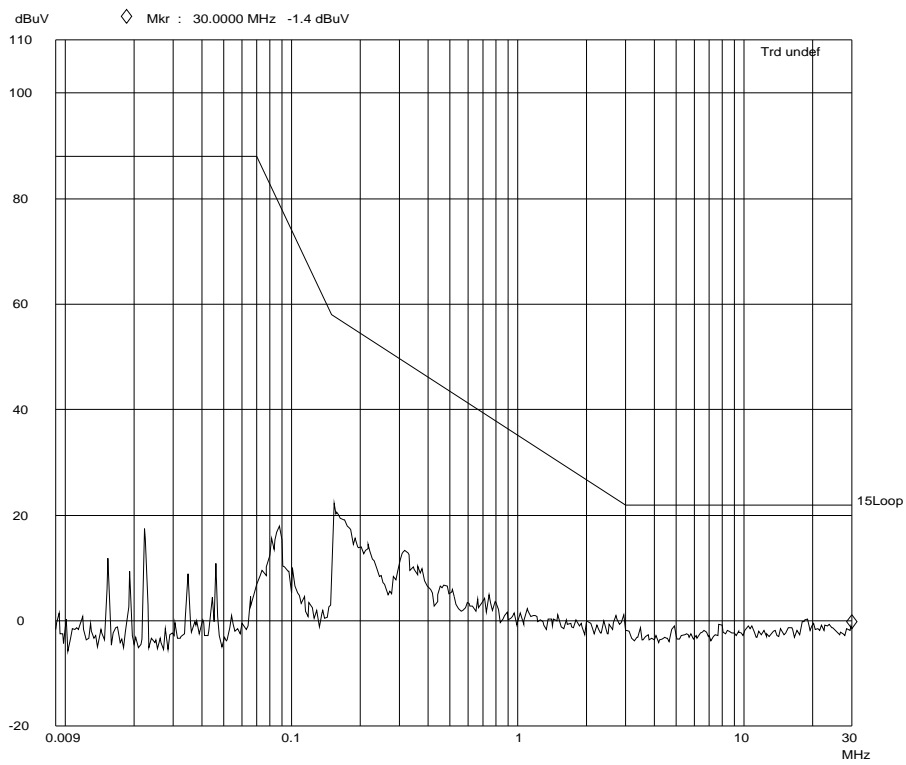

Model: EIP012C1200LS
X axis

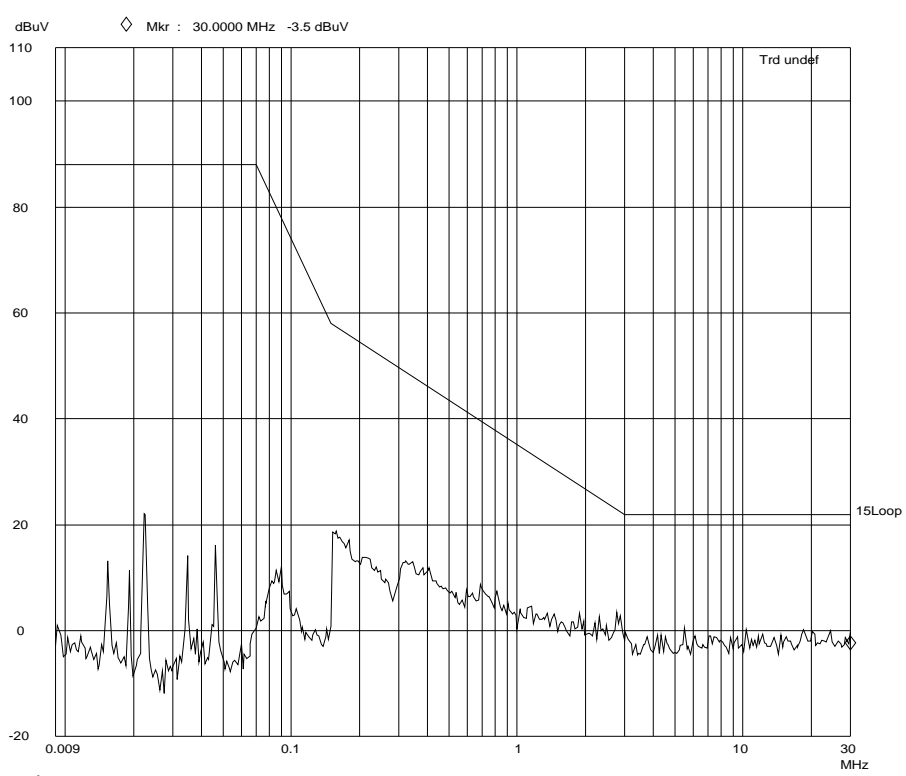

Y axis

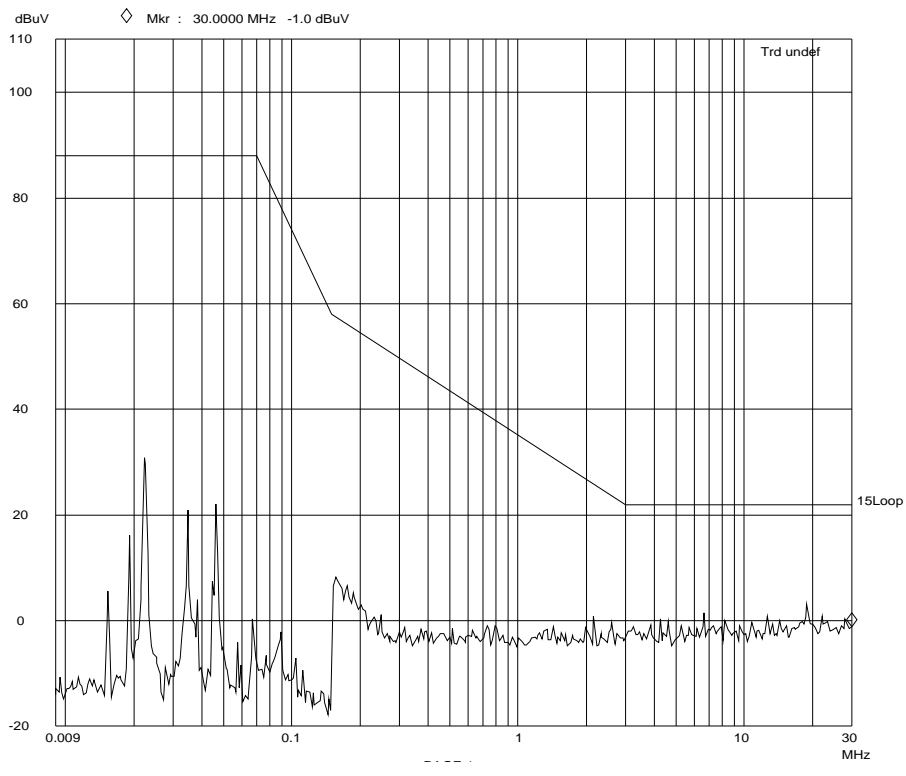

Z axis

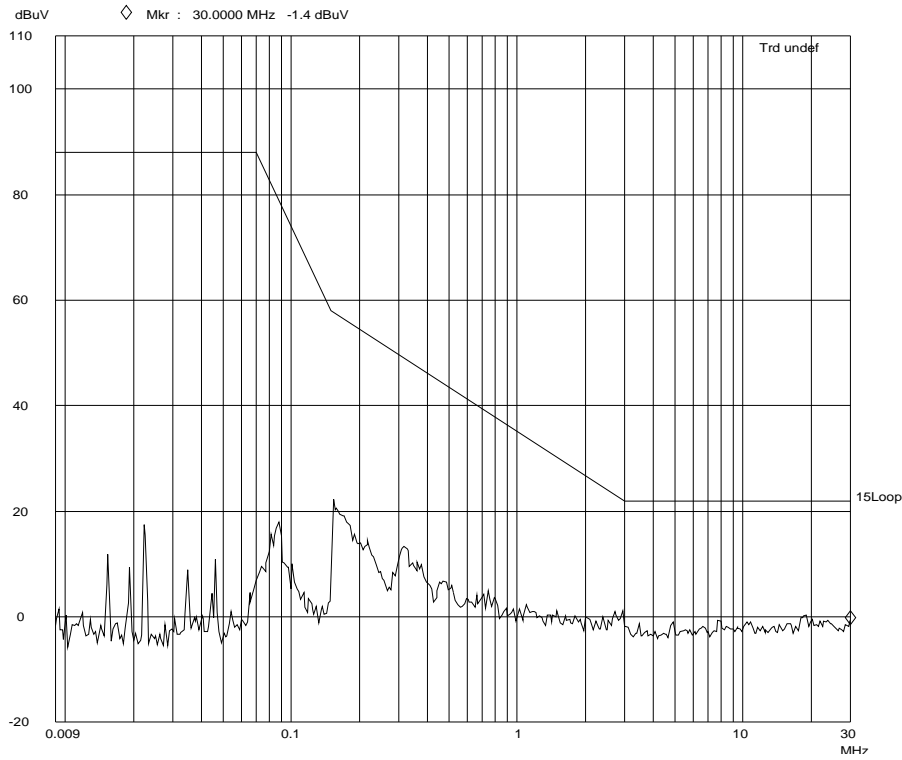

4.2.6 Measurement Uncertainty

The measurement uncertainty for induction current is under consideration according to CISPR 16-4-2:2003.

4.3 Radiated Electromagnetic Disturbance (30-300MHz, CDN method)

Test Result: Pass

4.3.1 Used Test Equipment

Equip. No.	Equipment	Model	Manufacturer
EM004-04	EMC shield Room	8m×3m×3m	Zhongyu
EM080-05	EMI receiver	ESCI	R&S
EM003-02	Coupling & Decoupling Network	CDN M2 16	TESEQ
EM003-01-05	Attenuator	6dB	drhubert

4.3.2 Block Diagram of Test Setup

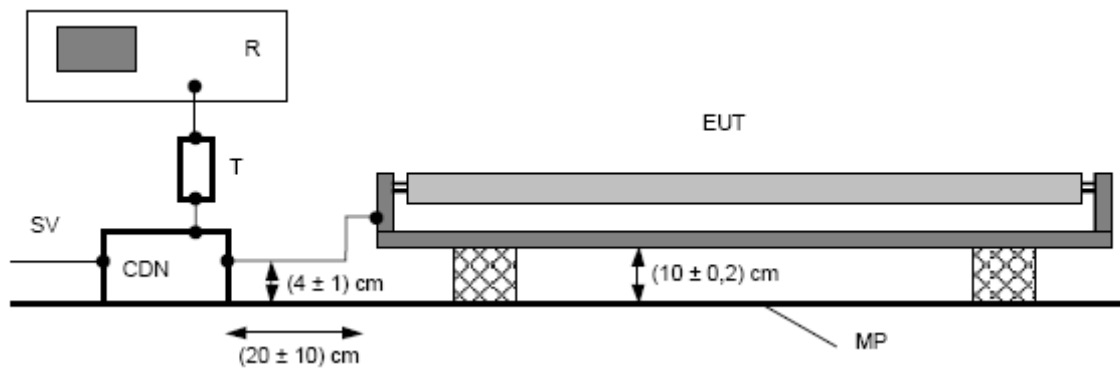

4.3.3 Test Setup and Procedure

The EUT shall be placed on a non-conducting table with a height of (10 ± 0.2) cm.

The EUT is connected to CDN with a length of (20 ± 10) cm and the distance of the cable to the metal plate should be (4 ± 1) cm.

The RF output of the CDN is connected to EMI receiver via a 6 dB, 50Ω attenuator.

The distance from any conductive parts shall be more than 40 cm.

Prior to a measurement, the lamps shall be operated until stabilization has been reached.

5min for incandescent lamps, 15min for fluorescent lamp, 30min for other discharge lamp.

The EUT should be powered on before the coaxial cable is connected to receiver every time.

And the coaxial cable should be removed from receiver before stopping EUT.

4.3.4 Test Data

EIP012C0250LS

EDIT PEAK LIST (Final Measurement Results)				
Trace1:	15CDN			
Trace2:	---			
Trace3:	---			
TRACE	FREQUENCY	LEVEL dBμV		DELTA LIMIT dB
1 Quasi Peak	67.44 MHz	51.41	L1	-5.85
1 Quasi Peak	71.64 MHz	50.02	L1	-6.74
1 Quasi Peak	87.84 MHz	44.68	L1	-10.38
1 Quasi Peak	30.16 MHz	52.19	L1	-11.75
1 Quasi Peak	36.12 MHz	50.53	L1	-11.92
1 Quasi Peak	40.04 MHz	48.97	L1	-12.63
1 Quasi Peak	61.32 MHz	43.26	L1	-14.79
1 Quasi Peak	95.04 MHz	37.99	L1	-16.43
1 Quasi Peak	46.36 MHz	41.85	L1	-18.53
1 Quasi Peak	143.6 MHz	35.13	L1	-18.86
1 Quasi Peak	146.72 MHz	34.96	L1	-19.03
1 Quasi Peak	118.32 MHz	32.56	L1	-21.43
1 Quasi Peak	225.44 MHz	31.93	L1	-22.06
1 Quasi Peak	193.6 MHz	31.53	L1	-22.46
1 Quasi Peak	196.2 MHz	31.47	L1	-22.52

EIP012C0700LS

EDIT PEAK LIST (Final Measurement Results)				
Trace1:	15CDN			
Trace2:	---			
Trace3:	---			
TRACE	FREQUENCY	LEVEL dBμV		DELTA LIMIT dB
1 Quasi Peak	67.16 MHz	51.25	L1	-6.05
1 Quasi Peak	71.64 MHz	49.69	L1	-7.08
1 Quasi Peak	86.24 MHz	44.74	L1	-10.48
1 Quasi Peak	30.04 MHz	52.15	L1	-11.83
1 Quasi Peak	35.64 MHz	50.45	L1	-12.11
1 Quasi Peak	61.6 MHz	44.56	L1	-13.45
1 Quasi Peak	40.48 MHz	47.91	L1	-13.59
1 Quasi Peak	101.64 MHz	40.04	L1	-13.95
1 Quasi Peak	144.76 MHz	35.42	L1	-18.58
1 Quasi Peak	147.48 MHz	34.96	L1	-19.03
1 Quasi Peak	47.68 MHz	40.90	L1	-19.24
1 Quasi Peak	122.16 MHz	32.61	L1	-21.39
1 Quasi Peak	194.32 MHz	31.51	L1	-22.48
1 Quasi Peak	197.36 MHz	31.47	L1	-22.52
1 Quasi Peak	228.2 MHz	30.64	L1	-23.35

EIP012C1200LS

EDIT PEAK LIST (Final Measurement Results)					
TRACE	FREQUENCY	LEVEL dBμV	DELTA	LIMIT dB	
Trace1:	15CDN				
Trace2:	---				
Trace3:	---				
1	Quasi Peak	69.76 MHz	51.83	L1	-5.15
1	Quasi Peak	71.48 MHz	51.60	L1	-5.18
1	Quasi Peak	82.48 MHz	43.31	L1	-12.29
1	Quasi Peak	50.6 MHz	46.68	L1	-12.97
1	Quasi Peak	61.48 MHz	44.03	L1	-14.00
1	Quasi Peak	46 MHz	44.79	L1	-15.65
1	Quasi Peak	30.36 MHz	47.33	L1	-16.56
1	Quasi Peak	96.56 MHz	36.50	L1	-17.79
1	Quasi Peak	39.24 MHz	43.57	L1	-18.20
1	Quasi Peak	110.8 MHz	35.31	L1	-18.68
1	Quasi Peak	144.92 MHz	34.98	L1	-19.01
1	Quasi Peak	146.56 MHz	34.96	L1	-19.03
1	Quasi Peak	192.04 MHz	32.82	L1	-21.17
1	Quasi Peak	196.56 MHz	32.02	L1	-21.97
1	Quasi Peak	229.92 MHz	31.09	L1	-22.91

4.3.5 Test Curve

EIP012C0250LS

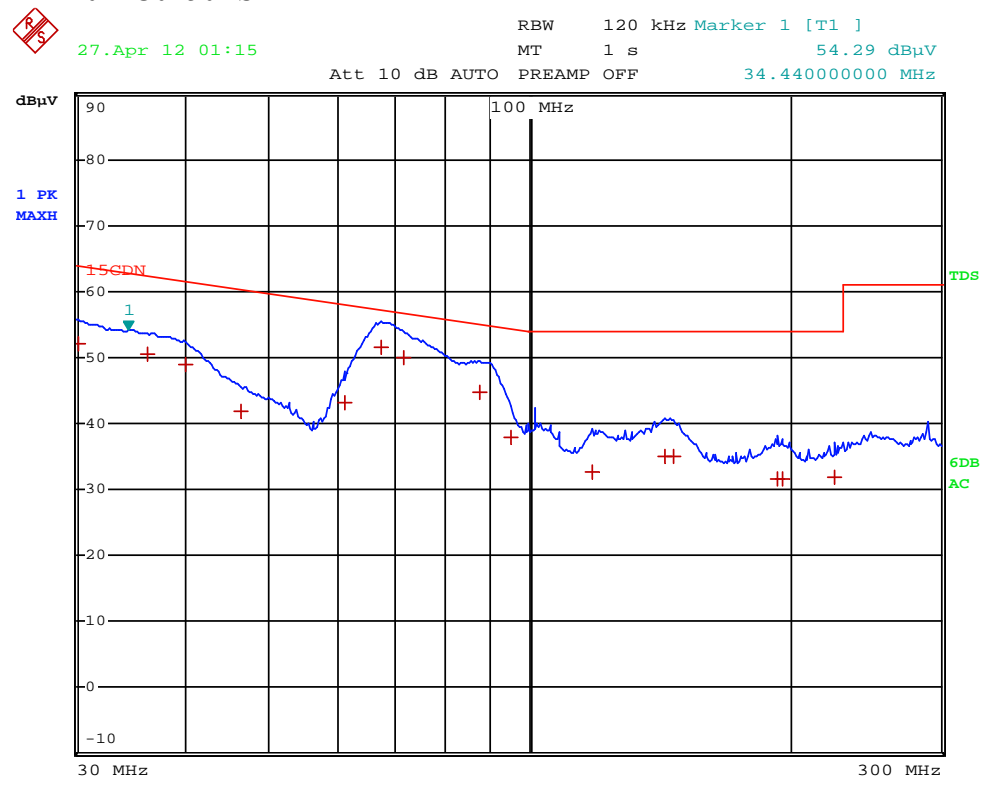

EIP012C0700LS



27.Apr 12 01:19

RBW 120 kHz Marker 1 [T1]
MT 1 s 54.27 dBuV
Att 10 dB AUTO PREAMP OFF 34.36000000 MHz

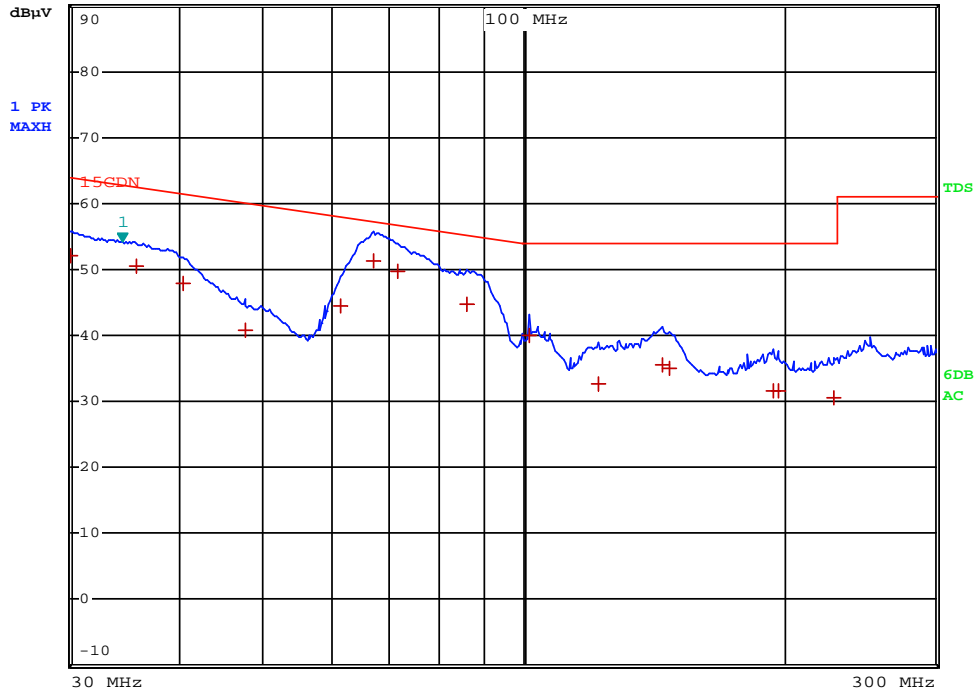

EIP012C1200LS



27.Apr 12 00:58

RBW 120 kHz Marker 1 [T1]
MT 1 s 49.54 dBuV
Att 10 dB AUTO PREAMP OFF 34.28000000 MHz

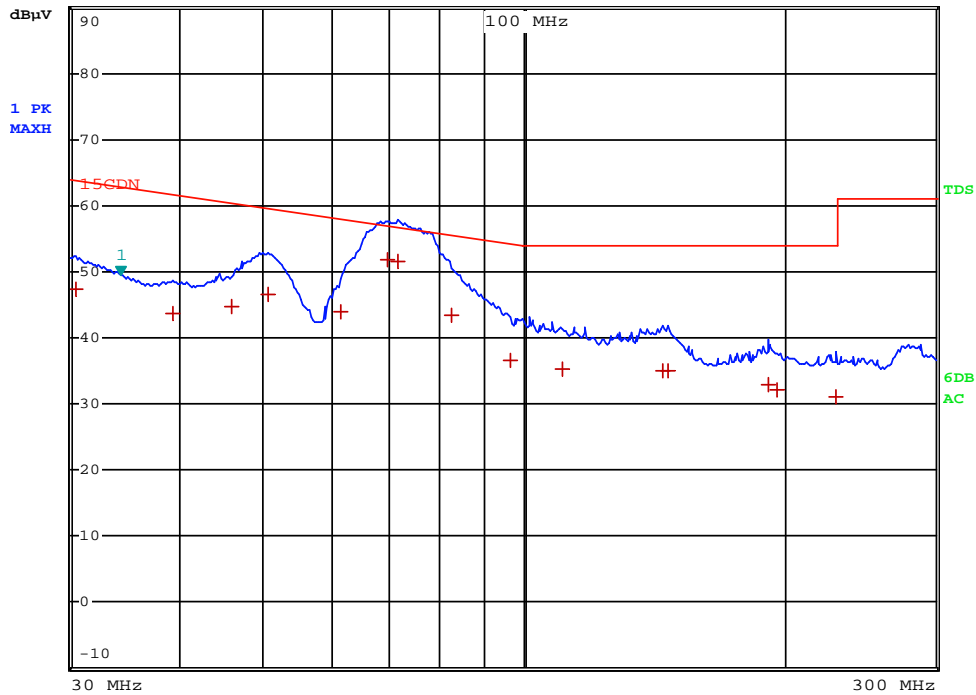

4.3.6 Measurement uncertainty

The measurement uncertainty for harmonic test is under consideration according to CISPR 16-4-2:2003.

4.4 Induced Current Density (20 kHz-10 MHz)

Test Result: Pass

4.4.1 Used Test Equipment

Equip. No.	Equipment	Model	Manufacturer
EM080-05	EMI receiver	ESCI	R&S
EM007-02	Van der Hoofden test-head	VDHH 9502	SCHWARZBECK
EM004-04	EMC shield Room	8m×3m×3m	Zhongyu

4.4.2 Block Diagram of Test Setup

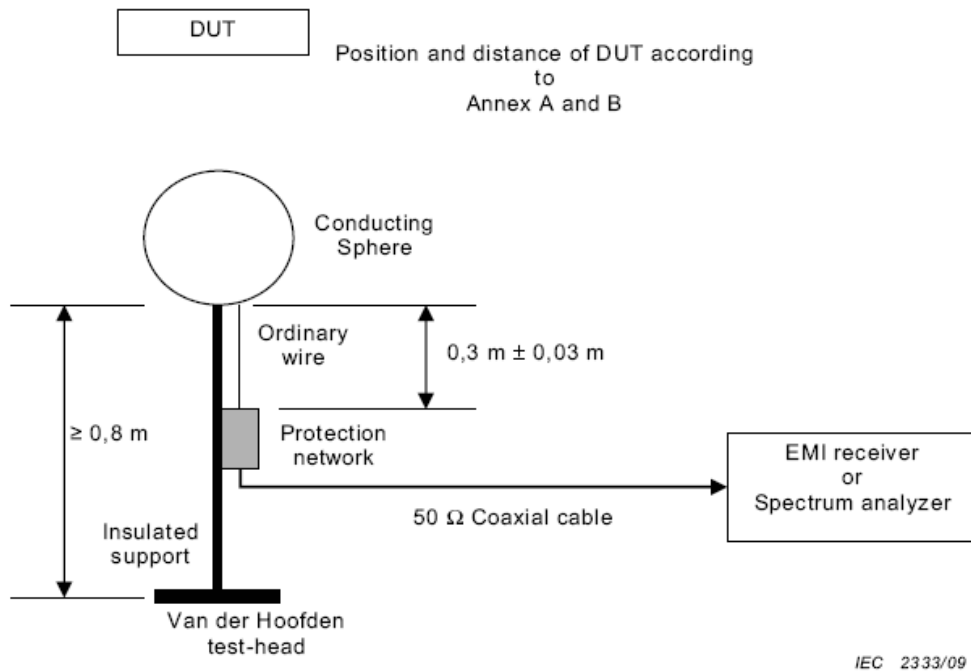

DUT = device under test.

4.4.3 Test Setup and Procedure

The height of the insulated support is minimum 0,8 m. The conducting sphere is connected to the protection network via an ordinary wire of length $30\text{ cm} \pm 3\text{ cm}$. The protection network is then connected to the EMI receiver, or spectrum analyser, by a $50\ \Omega$ coaxial cable having a maximum cable loss of 0,2 dB and a d.c. resistance of $\leq 10\ \Omega$.

Lighting equipment is evaluated in accordance with the measurement distance given in Table A.1 of Annex A unless otherwise specified by the manufacturer. The external surface of the test-head is taken as the reference point when determining the measurement distance.

Tolerances of the measurement distances are $\pm 5\%$.

If the lighting equipment is provided with an earthing terminal, the lighting equipment shall be connected by means of an earth conductor contained in the power cable to the lighting equipment.

During the tests no conductive plane or object or human being should be closer to the lighting equipment than 0,8 m.

Prior to measurement, the lamp(s) shall be operated until stabilisation has been reached.

Unless otherwise stated by the manufacturer, the following stabilisation times shall be observed: 15 min. for fluorescent lamps; 30 min. for other discharge lamps. All measurements have to be done with 100 h aged lamps.

4.4.4 Test Data

EIP012C0250LS: The factor is 0.051

EIP012C0700LS: The factor is 0.052

EIP012C1200LS: The factor is 0.050

$F_{limit} = 0.85$

4.4.5 Test Curve

EIP012C0250LS:

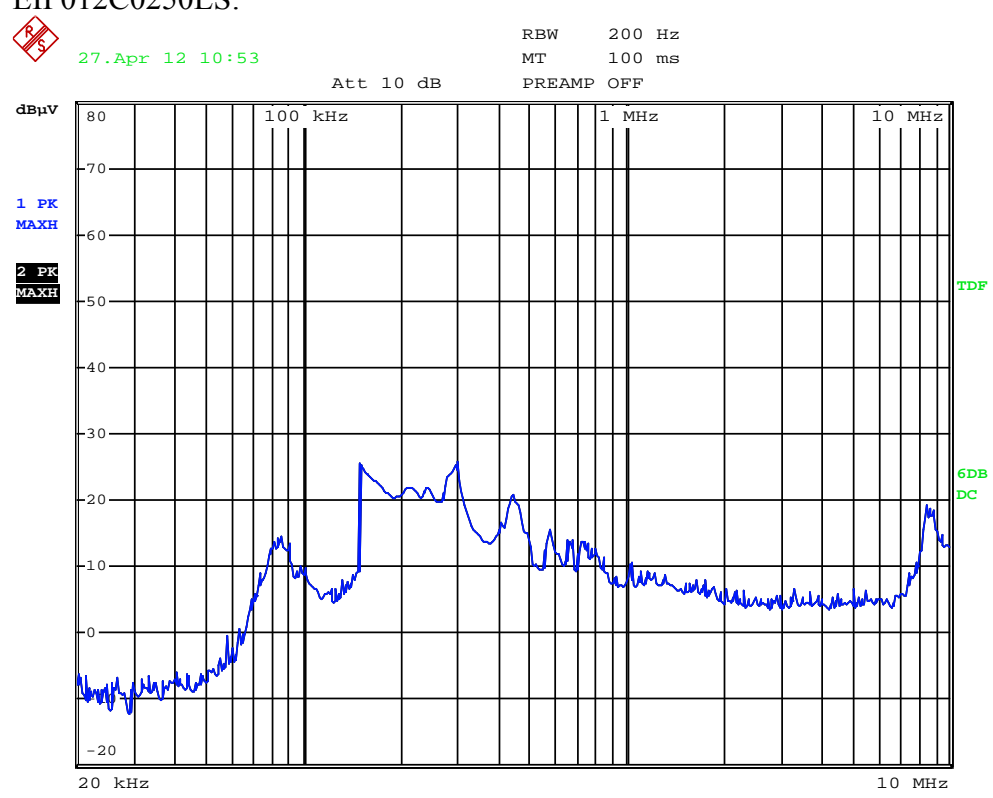

EIP012C0700LS:

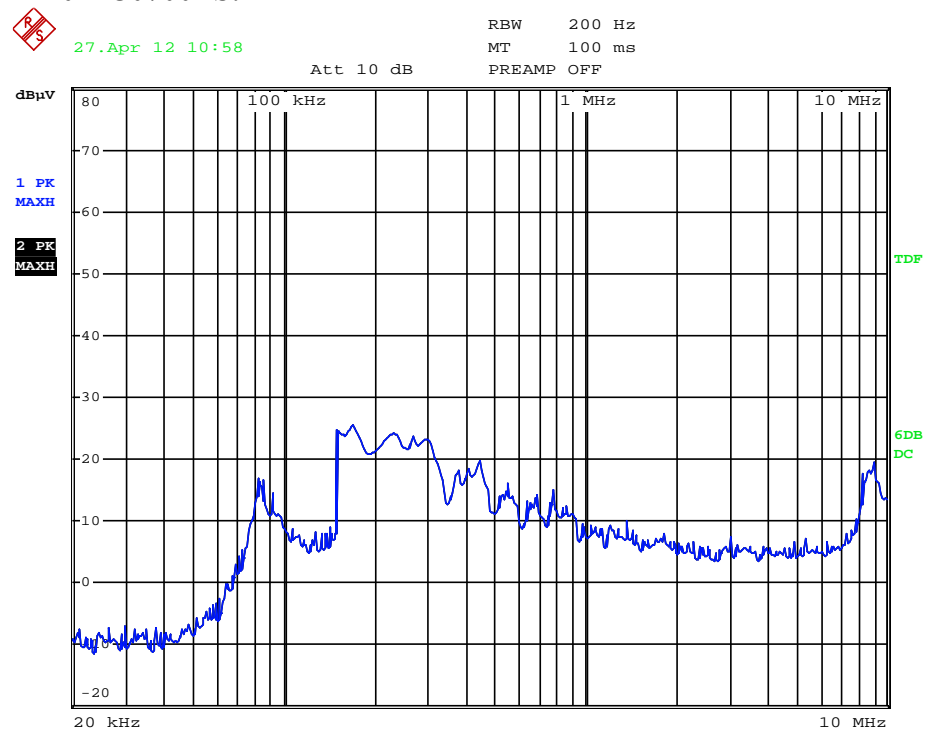

EIP012C1200LS:

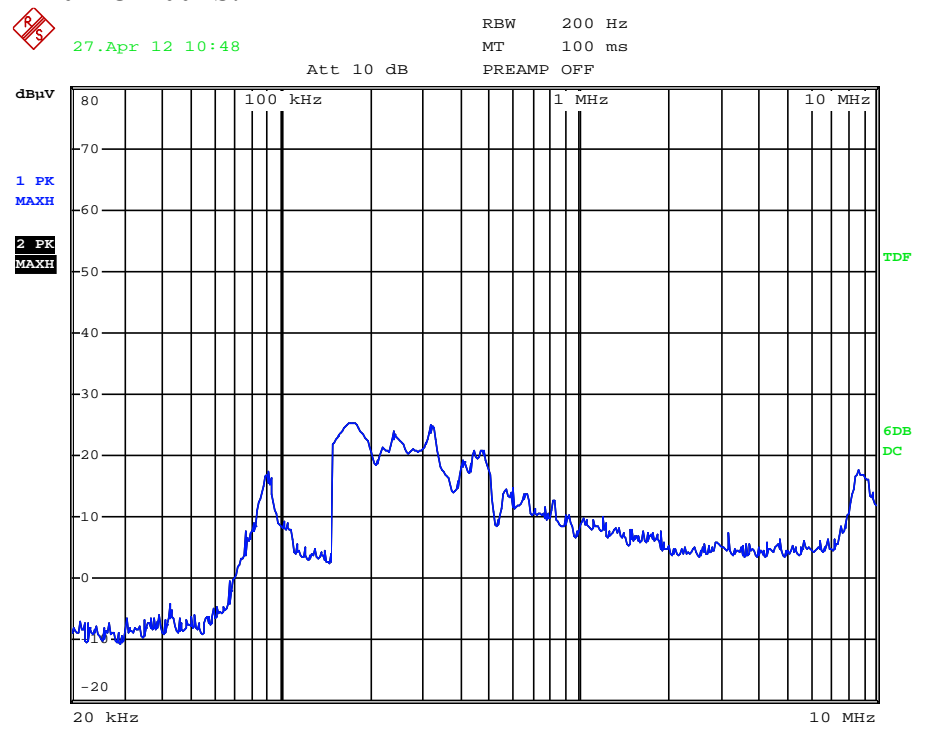

4.4.6 Measurement uncertainty

The measurement uncertainty for Induced Current Density test is according to CISPR 16-4-2:2003.

5 Appendix I - Photos of test setup

Conducted Emission



Radiated Electromagnetic Filed Disturbance



Radiated Emission(CDN method)

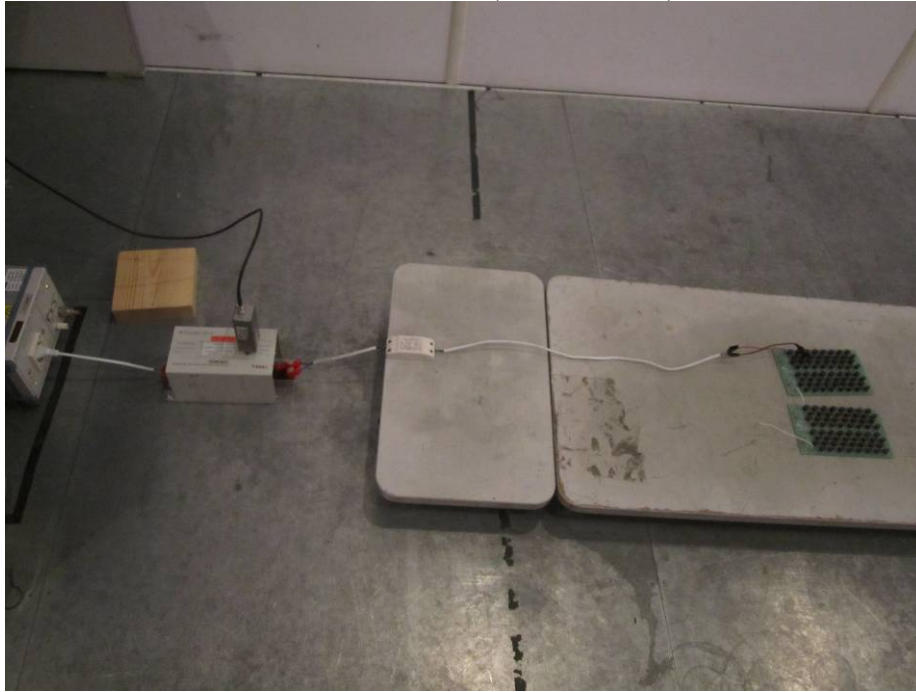

Induced Current Density

